

Range
—
SYDNEY



The mark of
responsible forestry



PRICELIST
PURCHASE – EURO

PRESS
01.01.2024



Range

SYDNEY

The SYDNEY round table can easily be recognized by the metal detail on the curved leg. The leg provides plenty of space for chairs all the way around and the table also comes in versions with extension – with room for 4 leaves.

Designed by

Cecilie Kamp



This range include

Dining tables
Coffee tables

Social media

Follow and share with us on Instagram.

 @kristensenfurniture | #kristensenfurniture

Features



Design elements

Choose between with or without extension and several different edge profiles.



Sustainable choice

This product is produced with Certified wood FSC® 100%.



Wood colours

Choose between more than 10+ different wood colours in both ash and oak.



Custommade

In addition to our many standard sizes we can accommodate special requests.

Pricelist- and imagebank

On our Collection-site you as a retailer always have access to the latest pricelists and hundreds of high resolution images and videos - **Free to use in your marketing!**

If you do not have a password yet, please contact the Kristensen sales office in Denmark.

LINK:

collection.kristensen.com

PRICELIST

SYDNEY Table (undevided)



Price: Round dining table w/undevided plate (H: 74 cm, plate thickness 3 cm)			
Description	Item no.	Price (EURO)	
		Ash	Oak
Ø160 Undevided plate	F-SN3H-160		
Ø150 Undevided plate	F-SN3H-150		
Ø140 Undevided plate	F-SN3H-140		
Ø130 Undevided plate	F-SN3H-130		
Ø120 Undevided plate	F-SN3H-120		



Choose leg detail colour

See more information in the back of this pricelist!

- Black steel
- Vintage copper look
- Brushed Brass
- Brushed Stainless steel

Please notice

These tables are not made in sizes smaller than Ø120, or larger than Ø160 cm.

Ash is standard - Oak + 25%

All prices are purchase prices in Euro.

We accept no liability for any errors or omissions.

PRICELIST

SYDNEY Dining Table (extendable)

The extension system is hidden when not in use.



Price: Round dining table w/devided plate (H: 74 cm, plate thickness 3 cm)			
Description	Item no.	Price (EURO)	
		Ash	Oak
Ø160 Extension for 4 leaves*	F-SN3M-160		
Ø150 Extension for 4 leaves*	F-SN3M-150		
Ø140 Extension for 4 leaves*	F-SN3M-140		
Ø130 Extension for 4 leaves*	F-SN3M-130		
Ø120 Extension for 4 leaves*	F-SN3M-120		

* Comes with 2 support legs

Leaves - For tables with devided plate (Solid wood, plate thickness 3 cm)			
Description	Item no.	Price (EURO)	
		Ash	Oak
Ø160 Leaf 50x160 cm	F-SNT3-160		
Ø150 Leaf 50x150 cm	F-SNT3-150		
Ø140 Leaf 50x140 cm	F-SNT3-140		
Ø130 Leaf 50x130 cm	F-SNT3-130		
Ø120 Leaf 50x120 cm	F-SNT3-120		



Choose leg detail colour

See more information in the back of this pricelist!

- Black steel
- Vintage copper look
- Brushed Brass
- Brushed Stainless steel

Please notice

These tables are not made in sizes smaller than Ø120, or larger than Ø160 cm.

Ash is standard - Oak + 25%

All prices are purchase prices in Euro.

We accept no liability for any errors or omissions.

PRICELIST

SYDNEY Coffee Table



Price: Coffee table (H: 44 cm, plate thickness 3 cm)			
Description	Item no.	Price (EURO)	
		Ash	Oak
Ø110 Undevided plate	F-SNC-110		
Ø100 Undevided plate	F-SNC-100		
Ø90 Undevided plate	F-SNC-90		



Choose leg detail colour

See more information in the back of this pricelist!

- Black steel
- Vintage copper look
- Brushed Brass
- Brushed Stainless steel

Please notice

These coffee tables are not made in sizes smaller than Ø80, or larger than Ø120 cm.

Ash is standard - Oak + 25%

All prices are purchase prices in Euro.

We accept no liability for any errors or omissions.



FSC® CERTIFICATE

A commitment for a better tomorrow

We are happy to announce that from 2021 we have achieved the certification that enables us to offer FSC®-labelled products. FSC® stands for "Forest Stewardship Council" and is an international non-profit organisation dedicated to promote responsible forestry. FSC® certifies forests all over the world to ensure that they meet the highest environmental and social standards.

By signing this contract, we have committed ourselves to living up to stricter social requirements and a more sustainable production. We are proud of supporting the FSC® with their work in looking after the forest workers and the wood industry, as well as fighting unsustainable, illegal forestry and deforestation.

The FSC® certification is one of our key initiatives in creating a more sustainable production. We acknowledge that this sustainable transition is a longer journey and not something that happens overnight. But each day they we are committed in doing a little better than yesterday and keep making progress in this matter.

**PLEASE VISIT OUR WEBSITE FOR
MORE FSC® RELATED INFORMATION**

www.kristensen.com



The mark of
responsible forestry

WOOD COLOURS



Images for guiding purpose only!

The wood structure and colour will vary from ash and oak.

We therefore recommend using the wood samples/exhibition furniture to get a more accurate impression.



ASH C3 / OAK C3
Lacquered

We treated this wood with lacque.

C3 are only made for products without patination.



ASH C4 / OAK C4
Natural oiled

We treated this wood with our 'Natural oil'.



ASH C6 / OAK C6
White oiled

We treated this wood with our 'White oil'.



ASH C8 / OAK C8
Soaped

We treated this wood with soap.



ASH C11 / OAK C11
Dark grey oiled

We treated this wood with our 'Black oil'.



ASH C12 / OAK C12
Antique brown oiled

We treated this wood with our 'Antique brown oil'.



ASH C13 / OAK C13
Light grey oiled

We treated this wood with our 'Light grey oil'.



ASH C14 / OAK C14
Black stained & oiled

We treated this wood with black stain, and treated it with a wax oil.

C14 is for legs and storage furniture only!



ASH C15 / OAK C15
Mocca brown oiled

We treated this wood with our 'Mocca brown oil'.



ASH C16
Warm white oiled

We treated this wood with our 'Warm white oil'.

C16 is only for ash



ASH C20 / OAK C20
Grey brown oiled

We treated this wood with our 'Grey brown oil'.



ASH C44 / OAK C44
Black matt lacquered

We treated this wood with black stain, and treated it with matt lacque.

C44 is only for plates and can only be made for products without patination.



For more information about maintenance, please visit our website:
WWW.KRISTENSEN.COM



We also offers our own repairoils for our products
- contact us if you need a pricelist.

Ash is standard - Oak + 25%

All prices are purchase prices in Euro.

We accept no liability for any errors or omissions.

kristensen:kristensen®

All rights reserved Kristensen & Kristensen A/S

7 / 11

WOOD FINISH



UP

Without patination

The wood is planned and sanded to achieve a smooth surface.

With few and smaller knots.

Storage furniture can only be made with this finish!



SC

Soft Cracks

Naturally occurring cracks are made more visible which gives a rustic look with cracks in the surface.

May contain more and larger knots.

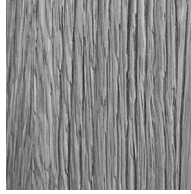

RL

Raw Look

We brush off the layer of softer wood which gives a look of wood that has been roughened by natural wear.

May contain more and larger knots.



FK

Filled Knots

The knots are filled and the wood is planned and sanded to achieve a smooth surface.

Only for OAK!

METAL COLOUR & FINISH

The bolts/bushes are always brass)



V

Vintage Copper ring + brass bolts/bushes

-
Rustic/tactile Vintage Copper look.

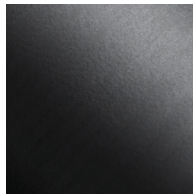

B

Black ring + brass bolts/bushes

-
Black painted (powder lacquered) steel.

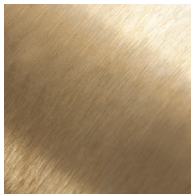

M

Brushed brass ring & bolts/bushes

-
Brass will get natural patina over time.

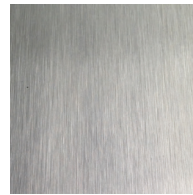

C

Brushed stainless steel ring & bolts/bushes

-
Brushed, stainless steel.

Do not use water or anyother liquid when cleaning – only use a dry cloth!

EDGE PROFILES



Edge profile 1

Harlekin (angled)



Edge profile 2

Arched



Edge profile 3

Pisa (rounded)



Edge profile 4

Straight



Edge profile 6

Wing

PRICELIST

Lazy Susan – turntable (rotating tray)

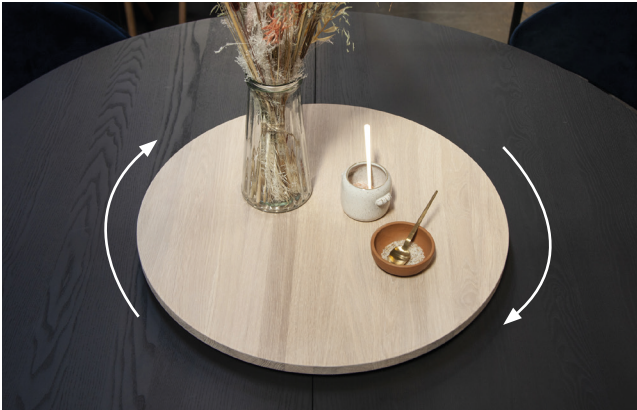

The plate has a turning function.
The product can be used with all our round dining tables.

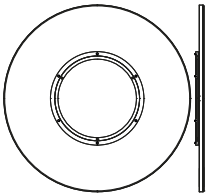
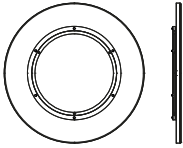
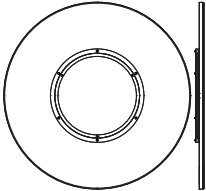
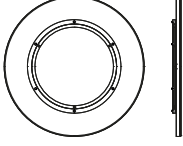

Price: LAZY SUSAN, plate thickness 2 cm				
description	item no.	measure (cm)		price (EUR)
		D	H	
 Lazy Susan turning plate in ASH	LAZY-80	80	4	
 Lazy Susan turning plate in ASH	LAZY-60	60	4	
 Lazy Susan turning plate in OAK	LAZY-80	80	4	
 Lazy Susan turning plate in OAK	LAZY-60	60	4	

Edge profile for
LAZY SUSAN



4
Straight edge

MEASURES

Measures for estimating the number of chairs fitting around these tables

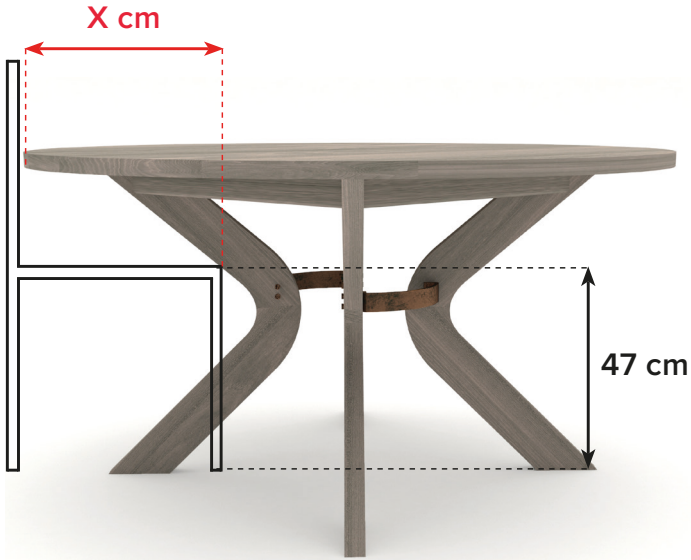

- Ø120 X = 32 cm
- Ø130 X = 37 cm
- Ø140 X = 42 cm
- Ø150 X = 47 cm
- Ø160 X = 52 cm

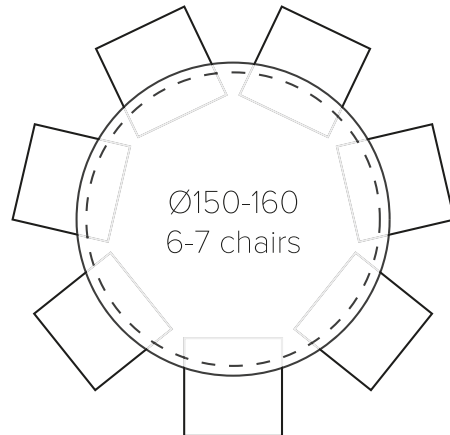
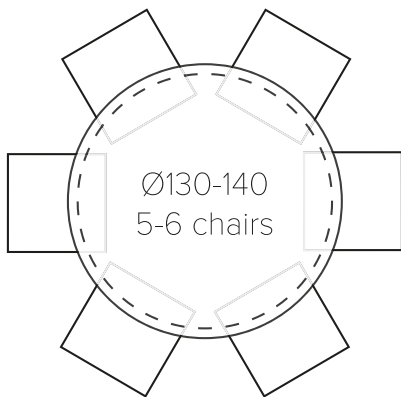
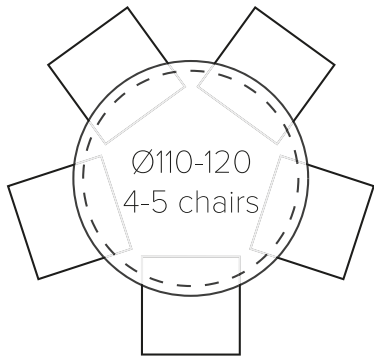

Ash is standard - Oak + 25%

All prices are purchase prices in Euro.

We accept no liability for any errors or omissions.

CONTACT

CUSTOMISED TABLES

We are able to produce all our table types in special sizes. Furniture in special sizes requires special handling both in terms of manual handling, new drawings, machine settings and packaging. We therefore include a surcharge for products in special sizes, whether the product will be larger or smaller. If you want a table in a smaller size e.g, the price is added 15% on the price of the nearest standard size.

Contact us for more information!

Agent, Norway

Paal Stenvaag

—

✉ post@mobelpaal.no

☎ +47 926 18 628

Agent, Finland

Jokko Salmevaara

—

✉ jokko.salmevaara@boknas.fi

☎ +358 401 958 886

Sweden

Steen Tokkesdal (temporarily)

—

✉ st@kristensen.dk

☎ +45 41 22 00 22

Agent, UK

Brendan Brett

—

✉ kristensen@theukagency.co.uk

☎ +44 77 34 265 599

Head office, Denmark

PHONE:

+45 75470303

ORDER MAIL:

order@kristensen.dk

ADDRESS:

Kristensen & Kristensen A/S
Storstrømsvej 44
6715 Esbjerg N
DK - Denmark

TERMS & CONDITIONS

—

Can be sent via email by request – contact:
kristensen@kristensen.com

WEBSITE:

www.kristensen.com

CLAIMS:

claim@kristensen.dk

MAIL:

kristensen@kristensen.dk

FAX:

+45 75470304

